

NOTE: REFER TO
DOOR HEAD: SS08RATU060

ATTACH SHEATHING WITH
APPROVED SCREWS
(TYPICAL @ EVERY STUD)

ATTACH CEMENT BOARD
WITH APPROVED SCREWS
(TYPICAL @ EVERY STUD)

WOOD BLOCKING

SLOPED THRESHOLD SILL

GYPSUM WALLBOARD,
VAPOR BARRIER (LOCATION DEPENDENT
ON CLIMATE ZONE),
STEEL STUD WALL,
BATT INSULATION (THICKNESS
DEPENDENT ON REQUIRED R-VALUE),
EXTERIOR SHEATHING,
CEMENT BOARD,
LATICRETE AIR & WATER BARRIER,
HI-BOND MASONRY VENEER MORTAR -
POLYMER FORTIFIED,
CALCIUM SILICATE TILE UNIT

WOOD BLOCKING

COMPRESSIBLE BACKER ROD AND
SEALANT ALL AROUND FRAME

SPRAY APPLIED FOAM INSULATING
AIR SEAL ALL AROUND FRAME

PREMANUFACTURED THERMALLY
BROKEN ALUMINUM DOOR ASSEMBLY

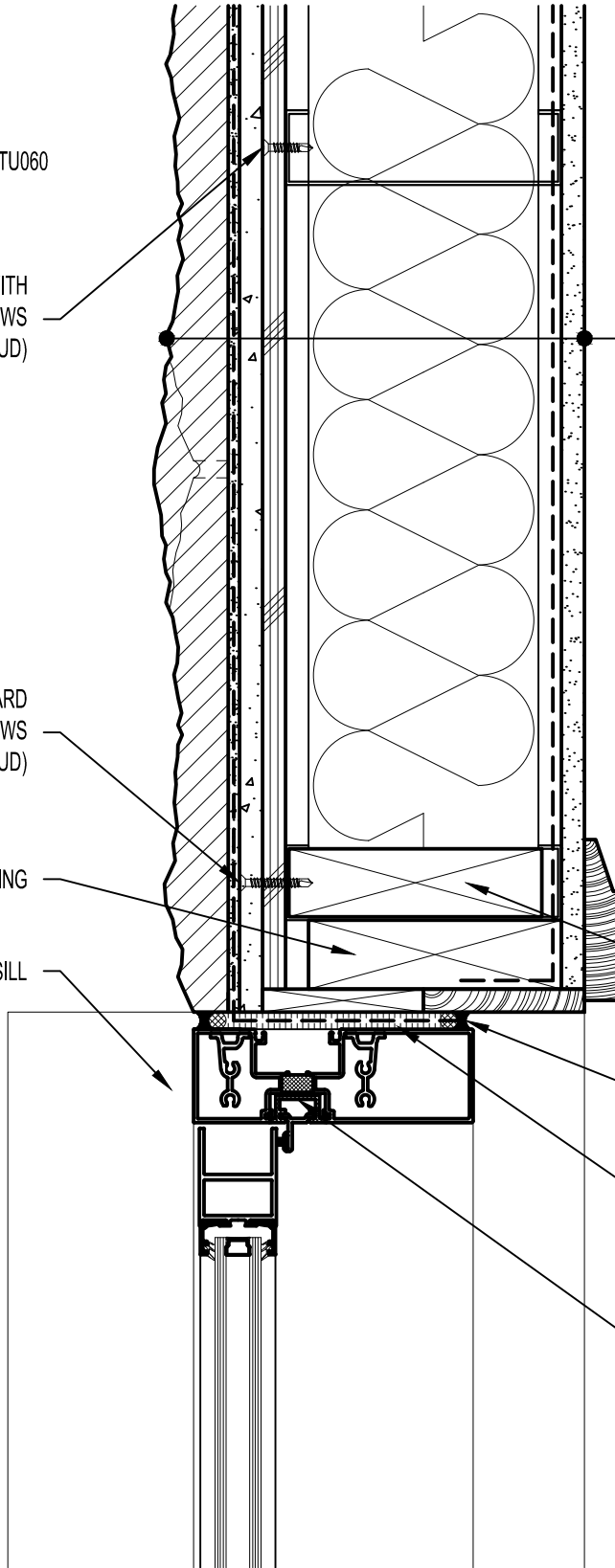

Arriscraft
Building Stone · Brick · Limestone

ARRISCRAFT-CADD

DETAIL No:

SS08RAT

TITLE:

ALUMINUM DOOR JAMB
(PLAN VIEW)

U070

DATE DRAWN:
03/02/15

SCALE:
3"=1'-0"

DRAWN BY:
TRI