

Real **Brick**. Real **Thin**. Right **There**.

authentic
brick

by MERIDIAN® BRICK



manufactured by

MERIDIAN®
BRICK



Get the skinny on the new face of genuine clay brick.

You've never seen or worked with a brick quite like this before. Authentic Brick by Meridian® Brick is the exciting new way to transform your home or business in ways you never thought possible.

Wow. That was easy.

Homeowners like Authentic Brick for the warm, comforting colors and eye-pleasing textures it brings to any room in the house. But what you'll really love is the ease of installation. Authentic Brick is made from real fired clay brick, yet it's also light and versatile. It can be easily installed on virtually any existing wall surface. With Authentic Brick, you can transform any space into a cool new look or accent that will leave you asking: "Why didn't I do this sooner?"

Endless possibilities.

From man caves and wine cellars to kitchens and outdoor patios, Authentic Brick is made to revitalize and renovate your rooms like no other product. It's real thin brick that makes a real difference, right there where you need it.



Interior Adhesive Installation

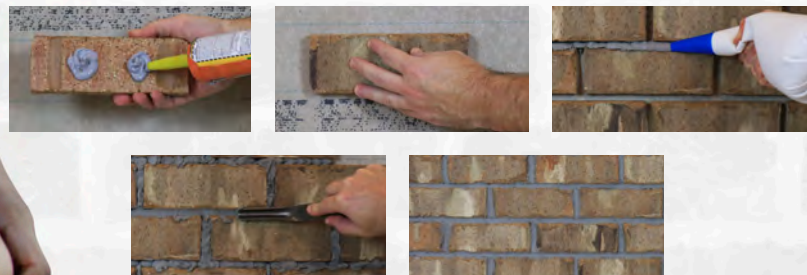

*Pictured: Riverbend (made-to-order)
Cover: Old Williamsburg*



Real Brick. Real Thin. Right There.



Features & Benefits

REMEMBER WHEN BRICK WAS CONSIDERED HEAVY AND CUMBERSOME? Not anymore. Today, thin is in. Especially if you want to achieve the rich aesthetics of real clay brick – without having to worry about any downside. Brick has changed. Have you? Here’s a whole house full of reasons to consider Authentic Brick for your next project.



Cottonwood

LIGHTWEIGHT – Install on nearly any sound structural interior/exterior surface. It’s 3” thinner and 70% lighter than dimensional brick.



Port Huron

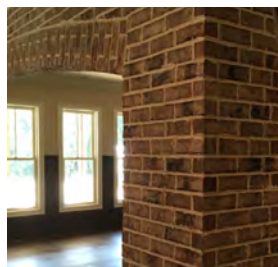

Coastal Bluff

MATCHING FULL BRICK – Love your Authentic Brick but want to go old school? Ask us about using it as full dimension brick.



Port Huron

ENVIRONMENTALLY FRIENDLY – Manufactured from natural materials and free of volatile compounds for your health and comfort.

EASY TO INSTALL – Unlike full bed brick, applying thin brick to a substrate can be a do-it-yourself project or installed by experienced trades people.

MADE FROM REAL FIRED CLAY BRICK – Crafted from classic materials for an authentic appearance – just thinner.

VERSATILE – Add the warmth and sophistication of real clay brick to any new construction or renovation, inside or out, residential or commercial.

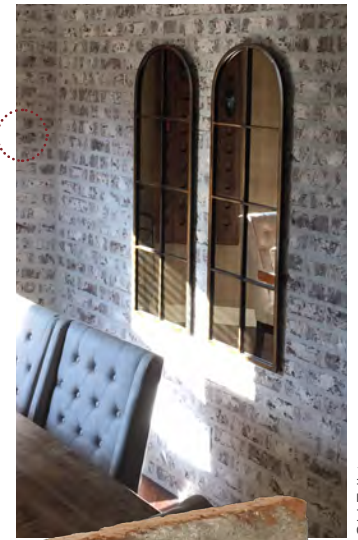

Old Edisto



CHOICES. CHOICES. CHOICES. Authentic Brick offers 39 colors in stock and ready to ship to you – we also offer hundreds of made-to-order choices. Contact us for availability.

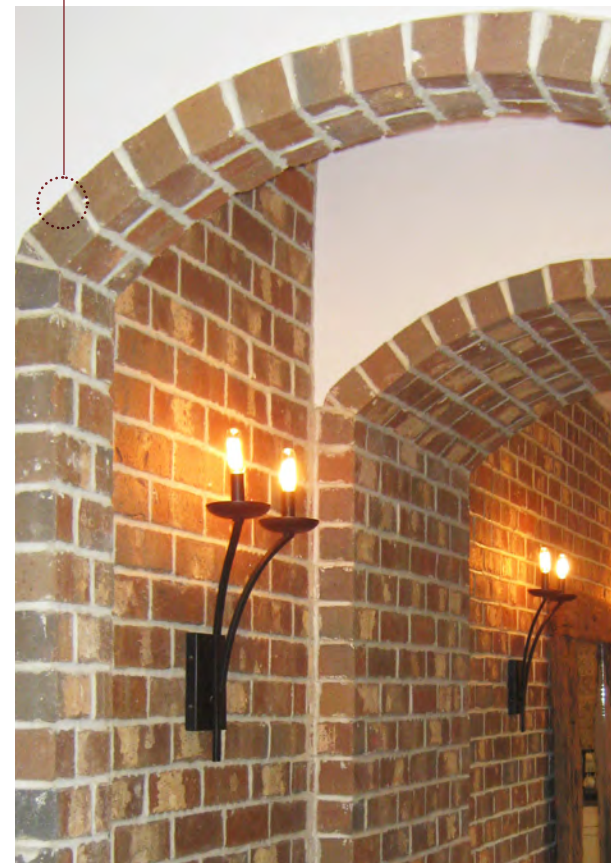

Old Williamsburg

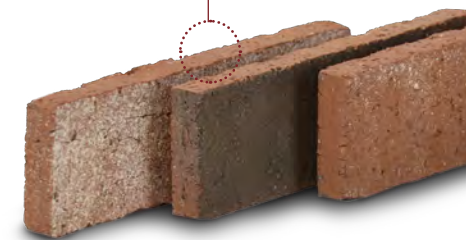

Modular Size

IN STOCK COLOR OPTIONS

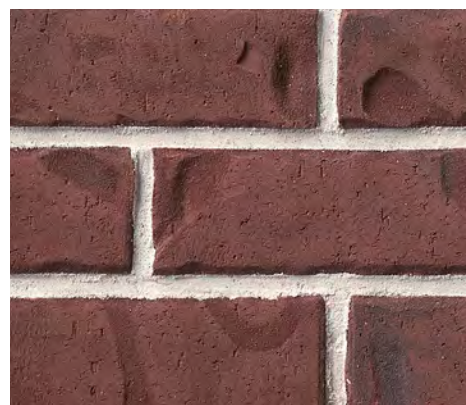
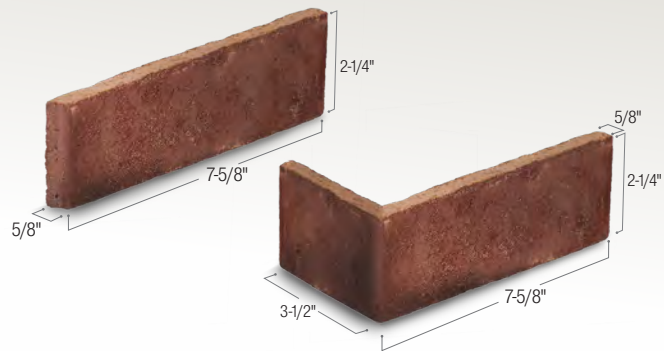

Grand River



Hemlock



Amaro



Meadowbrook

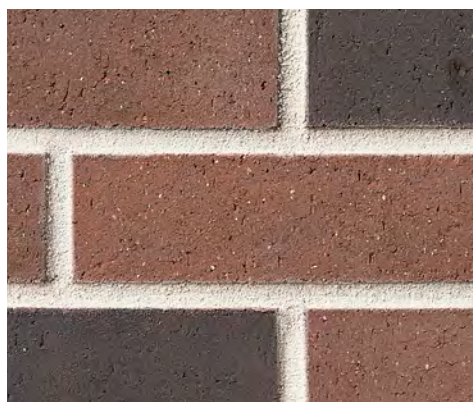

Arenac



Charlevoix

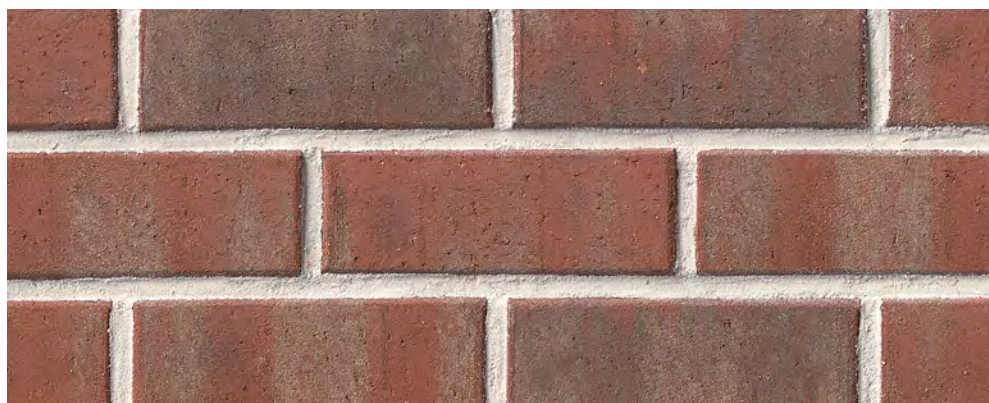

Colony Bay



Swan Creek

Modular
Size
IN STOCK COLOR OPTIONS

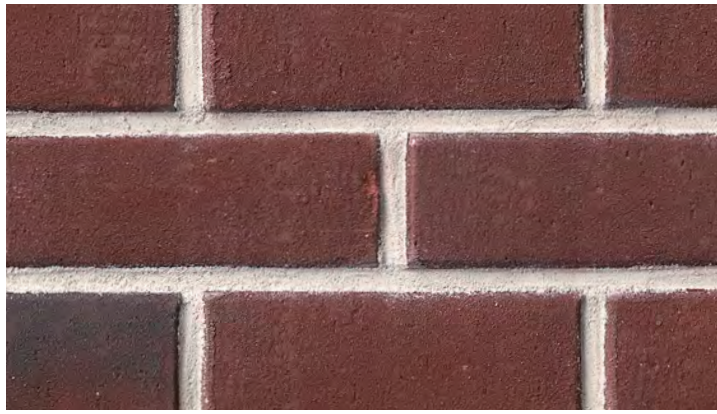

Mulberry



Shiawassee

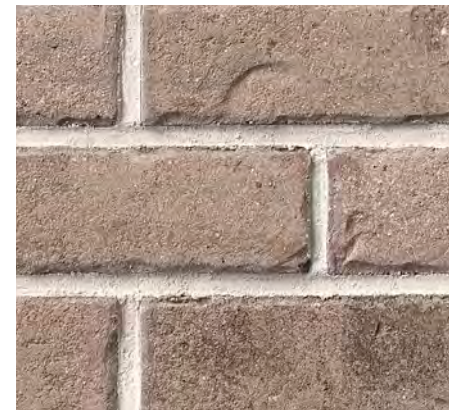

Swan Creek



Port Huron



Royal Oak



Tierra



Shiawassee



Queen Size
IN STOCK COLOR OPTIONS

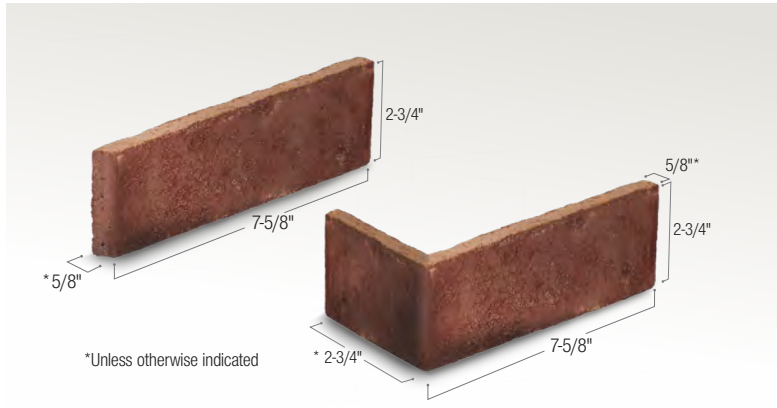

Capers Island



Alamo (*3/4" thickness)



Coastal Bluff



Cordoba



Old Guignard



Cottonwood (*3" corner return)



Magnolia Bay



Marsh Pointe

Queen Size
IN STOCK COLOR OPTIONS



Mt. Rushmore (*3/4" thickness)



Cottonwood



Capers Island



Olde Columbia



Old Edisto



Old Guignard (*3/4" thickness)



Old Williamsburg (*3" corner return)



Sandy Creek



Cottonwood

Queen Size
IN STOCK COLOR OPTIONS



Savannah Gray



Savannah Moss (*3" corner return)



Scarlet Oak Blend



Spanish Moss Blend



Tobacco Road



Cottonwood



Old Williamsburg

King Size
IN STOCK COLOR OPTIONS

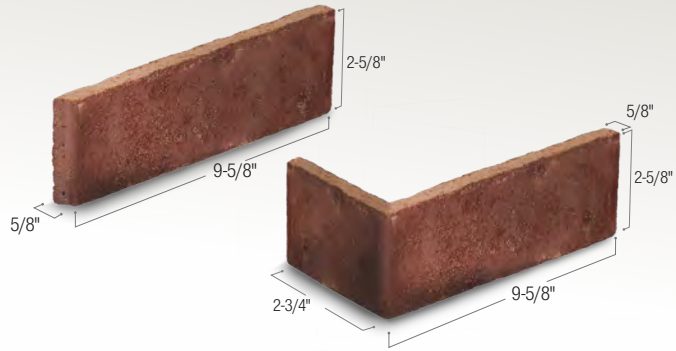

Grand Chenier



Madrono



Chestnut Hill



Fireside



Ridgemont



Silverado



Silverado



Wells Valley



Winslow



Residential Uses

IT'S NOT SO MUCH WHERE TO USE AUTHINTIC BRICK TO CREATE A FABULOUS LOOK – AS MUCH AS IT IS WHERE CAN YOU NOT ENJOY IT? Try this: walk around your home and look at the walls in each room. Can you imagine how the addition of Authentic Brick will transform any room or space? Now walk around the outside of your house. Same deal. To transform your home in a big way, think authentic.



V228 (made-to-order)

Here are some ideas for all the rooms in your home:

FIREPLACE FACING

OUTDOOR KITCHEN AND HARDSCAPE

EXPOSED FOUNDATION WALL

HOME ADDITIONS

EXTERIOR GABLE PEAKS

WINE CELLAR

VAULTED CEILING

BASEMENT REMODEL

PORCH OR PATIO

WET BAR

SIDING REPLACEMENT

DINING ROOM FEATURE

HOME OFFICE UPGRADE

KITCHEN BACKSPLASH



Swan Creek

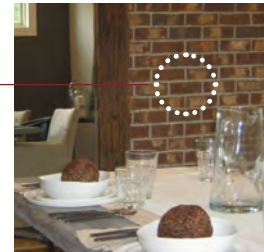

Old Williamsburg

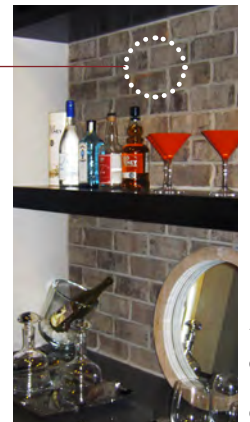

Swan Creek



Cottonwood



Commercial Uses

WHAT MAKES AUTHINTIC BRICK THE IDEAL BRICK IN COMMERCIAL APPLICATIONS?

For starters, consider what it takes away. It's lightweight. It eliminates the need for shelf angles, steel lintels and foundation support – so your structural requirements are reduced. Authentic Brick can be installed virtually anywhere you want the warm and rich look of genuine brick without the worry of having a structure to support the weight of typical full sized clay brick.

Now consider what it adds. Thin brick is thinner so you end up with more usable floor or green space. The lighter weight gives you more design freedom – including easily mixing with other façades – while still meeting the new energy codes for continuous insulation. You'll also benefit from efficient, year-round installation and the ease to remove for future renovation. This is a brick you're sure to love working with.



Old Williamsburg

EXTERIOR CLADDING SOLUTION FOR ALL BUILDING TYPES

RESTAURANT INTERIOR AND EXTERIOR

TILT-UP CONCRETE PANEL PROJECTS

PRE-ENGINEERED METAL SUPPORT SYSTEMS

PROJECTS THAT REQUIRE CONTINUOUS INSULATION

PROJECTS WITH HIGH SEISMIC REQUIREMENTS

LOBBY, RECEPTION DESK AND OTHER CUSTOMER GREETING AREAS

PRECAST CONCRETE FAÇADE SOLUTIONS

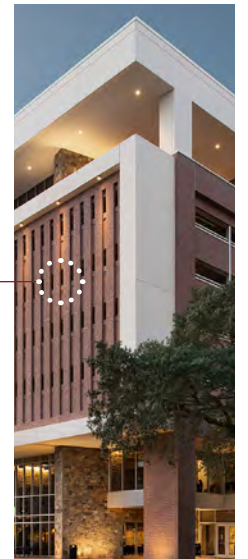

Old Williamsburg (in stock) and Waverly Mills (made-to-order)

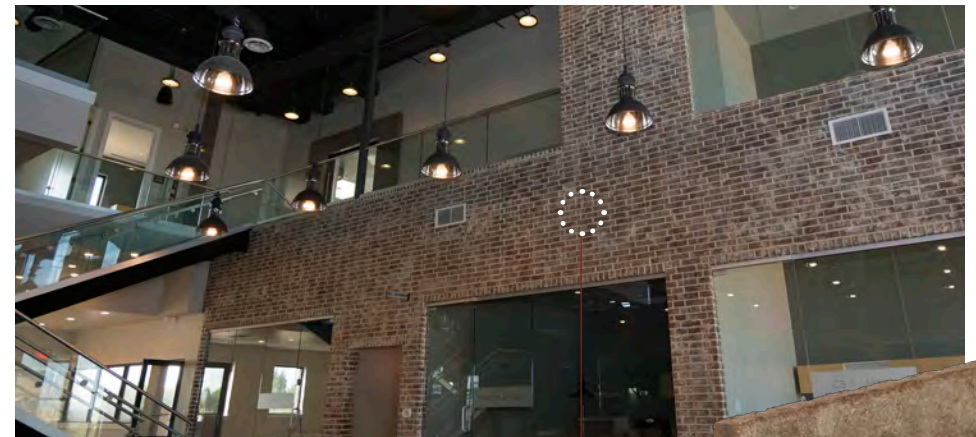

Riverbend (made-to-order)

COMBINE MATCHING FULL BRICK AND THIN BRICK

OUTDOOR EATING SPACES

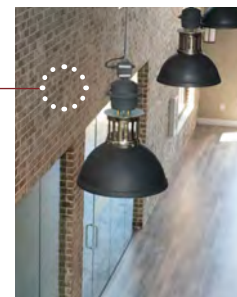

Riverbend (made-to-order)

HARDSCAPE AND SIGNAGE STRUCTURES

INTERIOR APPLICATION TO MATCH EXTERIOR MASONRY

INTERIOR AND EXTERIOR RETAIL BRANDING

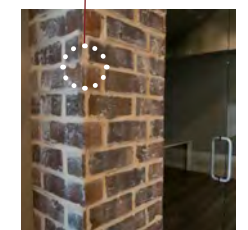

Riverbend (made-to-order)

Installation Options

For more information on which method is best suited for your project, visit authenticbrick.com.

Interior Adhesive Method

(DIY friendly!)

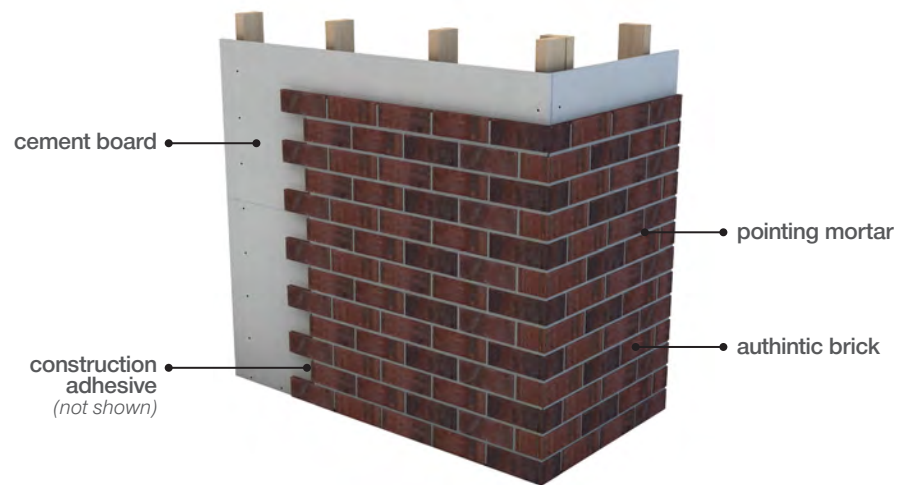

Thickset Method

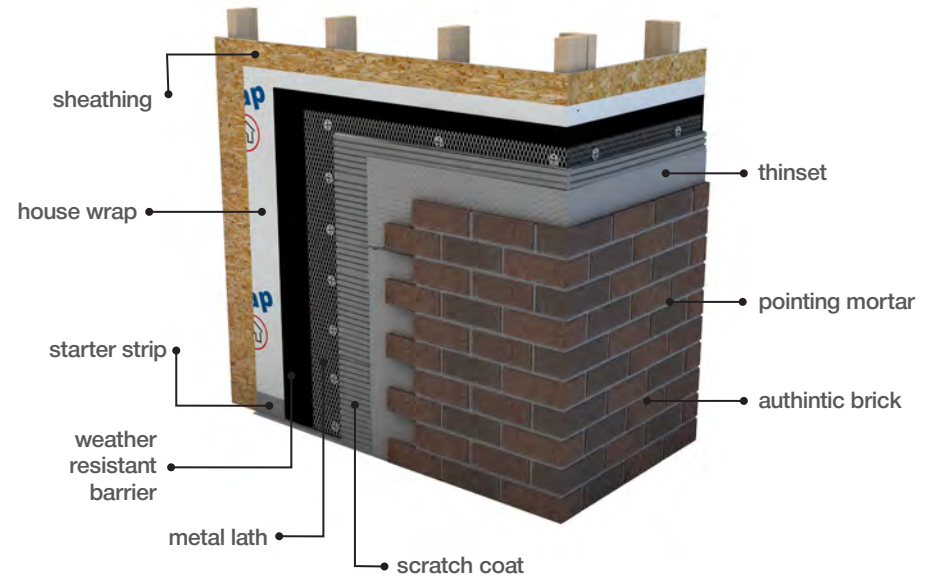

Metal Support System

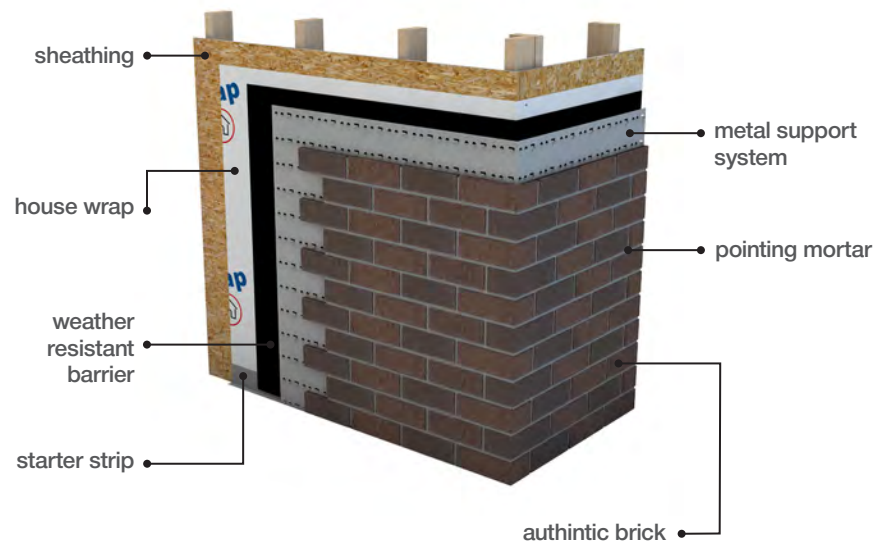

Thinset Method

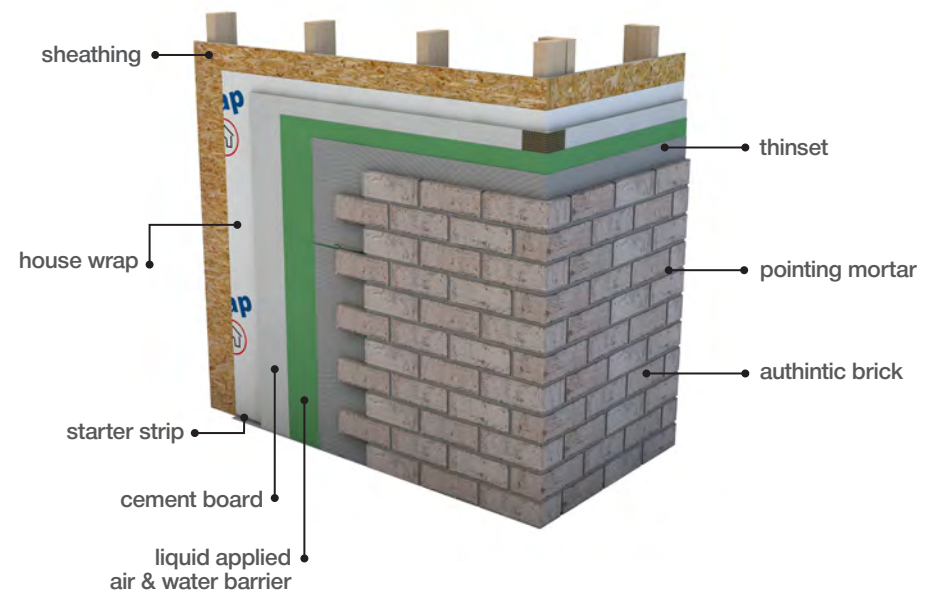



Be Bold. Be Brick.™

Picture: Riverbend (made-to-order)

Please note: This literature is intended to generally show the color range of the featured product. Using print and photography, it is impossible to show all colors, percentages of colors, texture and the harmless imperfections that may be contained in thousands of brick. Brick from different runs may vary slightly in color range and texture.

© Meridian Brick LLC - 0418
MBABPG02-0418



manufactured by
 **MERIDIAN®
BRICK**

Get the skinny.

For more information, to see more options or to discuss your next project, give us a call at **866-259-6263** or visit authenticbrick.com