

## Technical Bulletin – Caring For Your Brick Home

The clay brick units on your new home have been manufactured to meet the Severe Weathering (SW) Standards of the ASTM Specification, to be durable and long lasting and require very little maintenance. However, many of the associated components in the brickwork such as caulking, flashing, copings, sills and mortar joints do require periodic maintenance and inspection. Future improvements and modifications to your home such as landscaping and plantings, patio/paving additions, and grade changes can also affect the long-term performance of the brick on your home.

One key thing to remember is to avoid allowing your brick to be saturated with water, especially if you live in a cold climate location. Brick that are allowed to be saturated with water can lead to a problem referred to as “spalling”. Spalling is a condition where the face of the brick has separated from the rest of the body, usually 1/8” to 1/4” in depth. This delamination is the result of multiple cycles of freezing and thawing on a saturated brick. Soluble salts accelerate this process. When water saturates the pores of a brick and is then allowed to freeze, it exerts a tremendous amount of force (*think, pop bottle in the freezer*). Over time, the structure of the clay weakens and finally separates.

### To help ensure the optimal performance of your brick we wish to advise you of the following:

- Lawn watering and irrigation systems should be adjusted so that water is not sprayed on masonry surfaces
- The use of rock salt or other de-icing chemicals can have a very adverse effect on all types of masonry and concrete and will eventually cause deterioration. Because salt lowers the melting temperature of ice, the wall may go through more freeze/thaw cycles. Avoid piling snow up against this wall.
- Brick are not designed to be buried below grade by soil or landscaping mulch. The wall cavity is meant to breathe through weep holes (open head joints) at the base of the wall. Unless 6” to 8” of washed sharp stone at sufficient depth is installed against the brickwork to allow the wall to breathe and drain, soil, mulch or other organic material should not be piled against it.
- Gutters and downspouts are meant to carry water away from the structure and downspouts should be of sufficient length to discharge water where it cannot pond, pool or otherwise saturate the base of walls.
- Porch walls are susceptible to increased water from ground sources as well as wash-over from porch caps. Regular porch maintenance should include caulk at all brick/concrete interfaces including the underside of the cap where it contacts the brick below. Also, caulk all control joints in the cap to prevent water from draining into brickwork below.
- Slag sand is a commonly available setting bed material for segmental concrete pavers. However, this material often contains elements that are harmful to masonry. Slag sand is not recommended, instead use a washed river sand or mason’s sand.
- The International Residential Code requires 6” of slope away from a structure within the first 10 feet. Built-up landscaping can retain moisture and hold it against the brickwork.
- Chimneys are exposed to weather of all types at all times. When constructed properly, masonry chimneys are durable and functional. However regular inspection of the chimney should take place *bi-annually* and include inspection of brick/roof flashings and condition of the cap. For additional information refer to the Technical Bulletin: Masonry Chimney Maintenance / Repair.

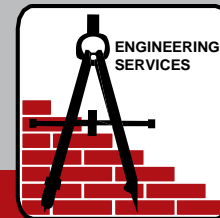

## Technical Bulletin – Caring For Your Brick Home

To help ensure the optimal performance of your pavers we wish to advise you of the following:

- For the installation of new pavers, weed control should be incorporated into the installation. This can come in the form of ground control such as weed matting or landscape fabric.
- For installed pavers, weed control may be necessary periodically. Proprietary vegetation killers may be applied for the management of weeds as they attempt to grow between pavers.
- Biological stains may form on pavers over time. Pressure washing can be utilized to remove these types of stains from pavers. These issues are more prevalent when pavers are located on the North side of homes as they receive less sun exposure.
- Joint sand has the potential to erode. This is especially true in areas with a lot of water runoff. Joint sand may need to be replaced periodically as a result.

### References

For additional information we suggest consulting the following references:

1. "Maintenance of Brick Masonry." BIA Technical Notes on Brick Construction, December 2017
2. "Repointing (Tuck-pointing) Brick Masonry." BIA Brick Brief, July 2005
3. "Efflorescence Prevention and Control." BIA Brick Brief, August 2009
4. "Ivy on Brickwork." BIA Brick Brief, July 2005
5. "Masonry Chimney Maintenance / Repair." General Shale Technical Bulletin

References 1 thru 4 are available on the BIA website [www.gobrick.org](http://www.gobrick.org). Reference 5 can be found on general Shale's website [www.generalshale.com](http://www.generalshale.com).

To achieve proper appearance, brick work needs to be cleaned after installation. The EaCo Chem Low Pressure EC Jet process, using agents recommended by General Shale, is preferred. This process includes the use of the EC Jet for chemical application and rinsing. If other methods or materials are used, it is strongly suggested they be tested for suitability on disposable panels of noncritical wall areas. This is especially important when pressure washing is used.

1. Keep the wall as clean as possible during construction in order to reduce the amount of cleaning necessary later.
2. For best results cleaning should be performed as soon as possible, **but not until**, initial mortar set has occurred, (typically 2-5 days). The heavier mortar stains should be removed as completely as possible by mechanical means (paddles, scrapers, brushes, etc.)
3. Select cleaning agent according to the following brick categories:  
**Category A brick** may be cleaned with an all-purpose commercial cleaning agent (at manufacturers recommended concentration). NMD-80 manufactured by EaCo Chem Inc. or equal is recommended.  
**Category B brick** may be subject to metallic staining and discoloration if abusively cleaned with ordinary proprietary cleaners. EaCo Chem Inc. NMD-80 or equal is recommended (at manufacturers recommended concentration).

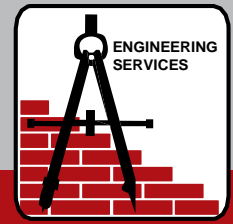

## Technical Bulletin – Caring For Your Brick Home

**Category C brick** have acid reactive coatings and may be subject to color range change if cleaned with acid-based cleaners. Non-acidic cleaners such as 1/2 cup tri-sodium phosphate (TSP) and 1/2 cup of laundry detergent per gallon of water is recommended for removal of general construction dirt.

**Note: General Shale never recommends using Muriatic Acid as a chemical for cleaning brick.**

4. If category classification is unknown, contact the local brick distributor, dealer, or General Shale representative.
5. Test clean – Select an inconspicuous wall area to confirm method and cleaning agents are satisfactory. Make adjustments as indicated.
6. Pre-wet masonry – Thoroughly pre-wet wall area to be cleaned. The moisture absorbing capacity of the masonry must be satisfied before cleaners are applied. (Low Pressure – 50 psi max -EC Jet with ball valve in the OFF position)
7. Clean – Apply cleaning agent to masonry in accordance with manufacturer instructions. For Category C, utilize bucket and brush method and scrub with acid resistant masonry brush. (Low Pressure – 50 psi max -EC Jet with ball valve in the ON position)
8. Rinse – (Low Pressure – 50 psi max- EC Jet with ball valve in the OFF position) Do not allow cleaning solution to dry on the wall. Rinse cleaner, dissolved mortar, and loosened dirt completely off the masonry wall with low pressure rinse.

**General Shale disclaims any and all responsibility for damages resulting from cleaning methods and materials. Failure to follow above cleaning recommendations will void product warranty.**

**Note: Additional brick cleaning information and guidelines for pressure washing methods can be found in the Brick Industry Association (BIA) Technical Note Number 20.**

# Maintenance of Brick Masonry

**Abstract:** Even though one of the major advantages of brick masonry construction is durability, periodic inspections and maintenance are needed to maximize the life of brickwork in structures. This *Technical Note* discusses the elements of suggested inspection programs and describes specific maintenance procedures, including replacement of sealant joints, grouting of mortar joint faces, repointing of mortar joints, removal of plant growth, repair of weeps, replacement of brick, installation of a dampproof course, installation of flashing in existing walls and replacement of wall ties.

**Key Words:** anchors, cleaning, dampproof course, efflorescence, flashing, inspection, maintenance, moisture penetration, mortar, repointing, sealant, ties, weeps.

## SUMMARY OF RECOMMENDATIONS:

### General Inspection

- Perform periodic inspections, preferably each season
- Use binoculars, adjacent roof areas and balconies to permit close-range observation of conditions at upper floors
- Use [Table 2](#), Brick Masonry Inspection Checklist, to document condition of brick masonry
- Supplement inspection checklist with photographs, sketches, and notes on floor plans or elevation drawings
- Use [Table 3](#), Possible Causes of Masonry Distress, to assess observed brick masonry conditions

### Water Penetration

- Investigate and determine moisture source(s) before attempting repairs to correct water penetration issues
- Scrutinize masonry with persistent efflorescence for unresolved water penetration issues

### Sealant Replacement

- Remove and replace torn, deteriorated or inelastic sealants and backer rod
- Use appropriately sized backer rod or bond breaker tape

### Mortar Joint Repair

- Determine if extent of cracking or deterioration warrants repair
- Where warranted, repoint or face-grout cracked or deteriorated mortar
- To formulate matching repointing mortar, consider testing existing mortar to determine original constituents and proportions
- For repointing, use prehydrated Type N, O or K mortar
- Install repointing mortar in multiple ¼-in. lifts, tooling each when “thumbprint hard”
- When selecting repointing mortar to match appearance of existing mortar, use mock-ups or sample panels

### Brick Replacement

- Break damaged brick to assist with unit removal
- Cut and remove remaining mortar without damage to adjacent units
- When selecting new brick to match appearance of existing brick, use mock-ups or sample panels
- Butter surfaces of new and surrounding brick; point joints around new units after installation

### Plant Removal

- Cut ivy and plant growth that contributes to moisture penetration or deterioration of brickwork; avoid pulling vines from wall
- Remove dried shoots with stiff fiber brush and detergent

### Retrofit Weeps, Flashing and Ties

- When weeps are clogged, carefully open to ensure that existing flashing is not damaged
- When weeps do not exist, carefully drill new weeps to ensure that existing flashing is not damaged
- In cases of rising damp, consider replacing base flashing or installing a dampproof course
- Repair or replace damaged flashing in alternate 2 to 5 ft (610 mm to 1.52 m) sections; use temporary bracing to install longer sections
- When anchors or ties are damaged or missing, install remedial anchors and ties in accordance with manufacturer’s recommendations; conduct in situ testing in a mock-up to confirm performance

### Coatings and Water Repellents

- Before considering application of external coatings, inspect masonry and correct all deficiencies

## INTRODUCTION

This *Technical Note* discusses maintenance of brick masonry with an emphasis on preventing moisture penetration. All buildings are unique and may require different levels of maintenance over time. A given solution for one project may not remedy similar issues on all buildings. When maintenance is required, it is suggested that the repair method selected effectively suit the needs of the particular building and not be based solely on maintenance performed on other buildings. Consulting a design professional experienced in the repair of buildings may be beneficial to systematically identify sources or causes of deterioration or water penetration and to provide recommendations for maintenance repairs.

Generally, brickwork that is properly designed, detailed and constructed using good workmanship will require very little maintenance over time. However, other components incorporated in the brickwork, such as caps, copings, sills, lintels and sealant joints, may require periodic inspection and repair. Neglecting maintenance of these components may lead to deterioration of other elements in the wall.

Maintenance of buildings consists of three primary components: 1) conducting general periodic inspections to document the existing condition of the building components and to identify any potential performance issues with the exterior wall; 2) performing known regularly scheduled maintenance tasks; and 3) executing specific repairs to correct any performance issues identified during the inspection. This *Technical Note* addresses both general and specific maintenance procedures for brick masonry. A checklist is provided for general inspections, and specific repair techniques are described.

Structural issues are more involved than maintenance and are outside the scope of this *Technical Note*. Generally, such issues warrant an investigation performed by a professional engineer to determine the cause of the issue and to recommend the appropriate repair method. However, indications of structural issues can sometimes appear similar to conditions that require maintenance. Examples of observed conditions that are structural include but are not limited to cracks in brick masonry exceeding 0.075 in. (2 mm) in width, cracks through multiple brick units, cracks following a stepped or diagonal pattern, widespread spalled brick, accumulated rust on lintels or shelf angles, out-of-plane movement of brick masonry or other wall elements, and neutral or negative slope on masonry sills and water tables.

## GENERAL INSPECTION

A thorough inspection and maintenance program may help extend the life of a building. It is a good idea to become familiar with the materials used in a building and how they perform over a given time period. **Table 1** lists the estimated time before repairs may be necessary for various building materials. These times are based on brickwork in vertical applications, constructed of proper materials and good workmanship and exposed to normal weathering conditions in the United States. Sills, parapets, chimneys and copings that experience more severe exposures may require repairs at shorter intervals. Brick pavers are outside the scope of this *Technical Note*. Refer to the *Technical Note* 14 Series for information on maintenance of brick paving systems.

**TABLE 1**  
**Estimated Time for Repair**

Material	Application	Estimated Time to Repair (Years)
Brick	Walls	100–150+
Sealant	Joints	5–20
Metal	Coping/flushing	20–75
Metal	Anchors & ties	15+
Mortar	Walls	50+
Plastic	Flashing	5–25
Paint	Finishes	3–5
Water Repellents	Walls	5–10
Stucco	Finishes	5–10

Periodic inspections should be performed to determine the condition of the various materials used on a building and whether repairs to those materials are necessary. These inspections can be performed monthly, yearly, biennially or on any schedule deemed appropriate and should include both the interior and exterior of the building. “Seasonal” inspection periods are recommended so that the behavior of building materials in various weather conditions can be observed. Documentation of each inspection should include comments, photographs and sketches to identify changes in materials, potential performance issues, and subsequent maintenance tasks or repairs. If possible, documenting conditions on floor plans or elevation drawings of the building can be helpful in identifying patterns of damage. Exterior surveys should be performed with binoculars to permit close-range observation of conditions on upper floors. Adjacent balconies or roof areas can also be used to observe portions of the facade that are difficult to see from the ground. Interior surveys should note stains or damage to finishes that may indicate potential water ingress.

Inspection records, including conditions and comments, should be kept to identify changes in materials, any performance issues and necessary repairs. When maintenance tasks or repairs are undertaken, documentation of the repairs should include before-and-after photographs. Both the inspection and repair records should be kept and referenced during future inspections to gauge when repairs were last completed and when repairs will become necessary. **Table 2** is a checklist of conditions that may require maintenance or repair. It is not all-inclusive; however, it may establish a guideline for use during inspections.

**TABLE 2**  
**Brick Masonry Inspection Checklist**

Location	Item or Condition	Building Elevation				
		North	South	East	West	
<b>Above grade</b>	<b>Masonry</b>	Cracked units				
		Loose units				
		Spalled units				
		Hairline cracks in mortar				
		Deteriorated mortar joints				
		Missing or clogged weeps				
		Plant growth				
		Deteriorated/torn sealants				
		Out-of-plumb				
		Efflorescence				
		Stains				
	Water penetration					
	<b>Flashing and counterflashing</b>	Damaged				
		Open lap joints				
		Missing				
		Stains				
	<b>Caps, copings and sills</b>	Inadequate slope				
		Cracked units				
		Hairline cracks in mortar				
		Loose units				
		Open joints				
Out-of-plumb						
Drips needed						
<b>Below grade</b>	<b>Foundation walls</b>	Deteriorated mortar joints				
		Cracks				
		Separation from flooring				
		Inadequate drainage				
		Water penetration				
	<b>Retaining walls</b>	Spalled units				
		Deteriorated mortar joints				
		Cracks				
		Out-of-plumb				
		Dampness				
		Inadequate drainage				
	<b>Other elements</b>	Roof overhangs				
		Gutters/leaders				
		Seal at adjacent materials				
Grade/drainage						



Conditions that may necessitate maintenance tasks or repair actions include efflorescence and other stains, spalling, deteriorating mortar joints, interior moisture damage and mold growth. Once one or more of these conditions becomes evident, the origin of the problem should be determined and action taken to correct both the cause and the visible effect of the condition. **Table 3** lists various conditions affecting brickwork and their most probable causes. The items checked in the table represent each cause that should be considered when such conditions are observed in brick masonry.

**TABLE 3**  
**Possible Causes of Masonry Distress**

Observed Condition	Potential Cause of Condition								
	Incompletely filled mortar joints (see TN7B)	Missing or clogged weeps	Plant growth	Deteriorated or torn sealant	Capillary rise	Missing or damaged flashing (see TN7 Series)	Differential movement (see TN18 Series)	Previous acid cleaning (see TN20)	Previous sandblasting
Cracked units	✓		✓				✓		
Spalled units	✓	✓		✓	✓	✓	✓		
Deteriorated mortar	✓	✓	✓		✓	✓	✓	✓	✓
Biological growth	✓	✓	✓	✓	✓	✓			
Efflorescence (see TN23 Series)	✓	✓		✓	✓	✓		✓	
Moisture-related stains	✓	✓		✓	✓	✓			
Corrosion of concealed materials	✓	✓		✓	✓	✓		✓	
Damaged interior finishes	✓	✓		✓	✓	✓	✓		

## SPECIFIC MAINTENANCE

After investigating all possible contributors, the actual cause(s) of distress conditions may be determined through the process of elimination. Often the source will be self-evident, as with deteriorated and missing materials; however, in instances such as improper flashing or differential movement, the source may be hidden and determined only through building diagnostics. In any case, it is suggested to first visually inspect for a self-evident source before performing a more extensive investigation, as it may save time and money in detecting the cause. Such a process should always be followed if the condition involves water penetration. Once the source is determined, measures can be taken to effectively remedy the moisture penetration source and its effects on the brickwork.

## Removing Efflorescence

Efflorescence consists of white deposits on the brick surface left when moisture carrying dissolved salts evaporates. *Technical Note 23A* discusses the causes of efflorescence in more detail and is an additional source of information regarding troubleshooting and removal of efflorescence.

Prior to cleaning efflorescence, potential water ingress issues in the area should be investigated and resolved; otherwise, the efflorescence will return. Any leaks should be repaired and the brickwork allowed to dry. Generally, efflorescence is water soluble and easily removed by natural weathering, by dry-brushing or by scrubbing with

a stiff fiber brush and water. Proprietary cleaners formulated specifically for use on brickwork are effective in removing heavy accumulations or stubborn efflorescence. For further information on removing efflorescence, refer to *Technical Note 20*.

Use solutions specifically manufactured to remove efflorescence from brickwork. Improper cleaning procedures such as insufficient prewetting, insufficient rinsing and strong chemical concentrations may cause additional staining, etched mortar joints and increase moisture penetration in brickwork. Stains caused by improper cleaning are not water soluble but can be removed by proprietary cleaners. To avoid improper applications of proprietary cleaners, it is imperative that the manufacturer's instructions be carefully followed.

All cleaning procedures should first be tried at different concentrations in an inconspicuous area to judge their effectiveness and potential harm to the brickwork prior to implementing at full scale. Additional recommendations and cleaning methods for brick masonry are presented in *Technical Note 20*. After cleaning, the mortar joints should be inspected. Repointing or grouting of the joints, as discussed later in this *Technical Note*, may be necessary.

## Sealant Replacement

Missing or deteriorated sealants in and between brickwork and other materials such as windows, doorframes and expansion joints may be a source of moisture penetration. The sealant joints in these areas should be closely observed to identify areas where the sealant is missing or was installed but has deteriorated, torn or lost elasticity. Deteriorated sealants should be carefully removed and the opening cleaned of all existing sealant material. The clean joint should then be properly primed and filled with an appropriately sized backer rod (bond breaker tape if the joint is too small to accommodate a backer rod) and a full bead of high-quality, elastomeric sealant compatible with adjacent materials. Sealant manufacturers should be consulted for the applicability and suitability of their sealants for expansion joint applications. Manufacturers recommend three generic types of elastomeric sealants for use on brickwork: polyurethanes, silicones and polysulfides. For more information on sealants, refer to *Technical Note 18A*.

## Mortar Joint Repair

Cracks of any size in masonry mortar can increase the potential for water penetration. However, the presence of cracks or deterioration in masonry mortar does not necessarily warrant immediate repair of the mortar joints. Many types of walls, such as cavity walls and veneer walls, are capable of managing increased moisture ingress through the exterior wythe due to minor cracks. Water penetration related to masonry cracks is more problematic for barrier or mass masonry wall construction. The location and number of cracks and deteriorated areas should be reviewed as part of the periodic inspections and correlated with any water leakage at the interior. When exterior cracks and deterioration correspond to uncontrolled water penetration, and other potential causes or contributions have been eliminated, repairing the mortar joints may be warranted.

Repairing cracked or deteriorated mortar joints will effectively reduce the amount of water that enters exterior masonry because the repair process restores the mortar integrity at the exterior face. While repairs may improve the existing bond between mortar and brick, they are unable to achieve the same level of bond performance established during original construction.

As previously stated, structural cracks in brickwork are beyond the scope of this *Technical Note*. These cracks often require professional investigation to determine the cause and appropriate method of repair. For photos and more information on various crack types, refer to *Technical Note 18*.

Two methods used to repair mortar joints are face grouting and repointing. While both have been used successfully, they are intended for different purposes and vary in performance. Repointing is generally recommended and is performed more often because the procedure is better suited to correct various types and severities of mortar joint deterioration compared with face grouting.

**Face Grouting of Hairline Cracks.** If mortar joints develop small "hairline" cracks, surface grouting may be an effective measure to fill them. The impact of surface grouting on brickwork aesthetics should be considered before work begins, as the appearance of the mortar joints will change, becoming slightly wider and less textured, as the aggregate will not be visible. A recommended grout mixture is 1 part portland cement, 1/3 part hydrated lime and 1 1/2 parts fine sand (passing a No. 30 sieve). The joints to be grouted should be dampened. To ensure good bond, the brickwork must absorb all surface water. Clean water is added to the dry ingredients to obtain a fluid

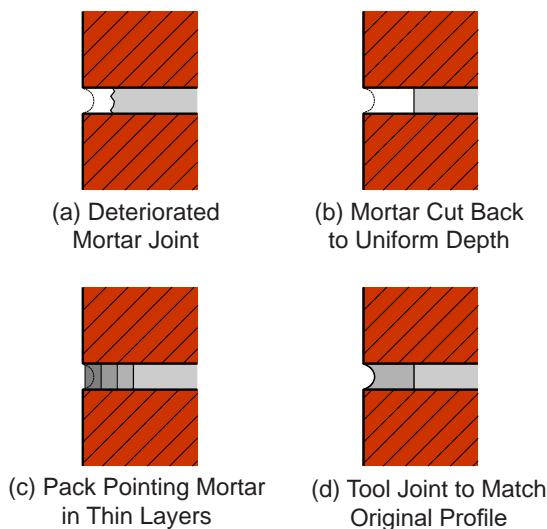



**Photo 1**  
Mortar Joints in Need of Repointing



**Photo 2**  
Repointing Mortar Joints



**Figure 1**  
Repointing Mortar Joints

consistency. The grout mixture should be applied to the joints with a stiff fiber brush to force the grout into the cracks. Two coats are usually required to effectively reduce moisture penetration. Tooling the joints after the grout application may help compact and force the grout into the cracks. The use of a template or masking tape is recommended to keep the brick faces as clean as possible.

**Repointing Mortar Joints.** Moisture may penetrate brick masonry through unbonded, cracked or deteriorated mortar joints, as shown in **Photo 1**. Several conditions that require repointing include mortar erosion exceeding  $\frac{1}{4}$  in. (6.4 mm), crumbling mortar, mortar with voids, hairline cracks in the mortar, and cracks between the brick and mortar. When this is the case, repointing (sometimes referred to as tuckpointing) is one of the most effective ways to reduce moisture penetration. Repointing is the process of removing damaged or deteriorated mortar to a uniform depth and placing new mortar in the joint, as shown in **Photo 2** and **Figure 1**. Visual observation of the joints, along with light scraping using a metal tool, are common methods for determining areas where repointing may be necessary.

Prior to undertaking a repointing project, the following should be considered: 1) The potential for power tools to damage the brick surrounding the mortar being removed. 2) Repointing operations should be performed only by qualified and experienced repointing craftspeople. An individual who is an excellent mason may not be qualified for repointing. Skills should be tested and evaluated prior to the selection of the contractor. 3) When repointing for historic preservation purposes, refer to “Preservation Brief 2: Repointing Mortar Joints in Historic Masonry Buildings” [Ref. 9].

The deteriorated mortar should be removed, by means of a tothing chisel or a special pointer’s grinder, to a uniform depth (refer to **Figure 1b**) that is the minimum of twice the joint width, generally  $\frac{3}{4}$  in. (19 mm), or until sound mortar is reached. Using a grinder to remove head joint mortar will not remove the full depth of material without damaging adjacent brick. The extra mortar left in the head joints must be removed by a chisel to achieve a uniform depth. Care must be taken not to damage the brick faces and edges. Thin “slivers” of mortar remaining on the brick must be removed in order to obtain good bond between the new repointing mortar and the brick. Remove all dust and debris from the joint by brushing, blowing with oil-free compressed air or rinsing with water.

Repointing mortar should be carefully selected and properly proportioned. For best results, the original mortar constituents and proportions should be duplicated. If the mortar type is unknown, then taking samples of the original mortar and sending them to a testing laboratory is recommended to help determine the ingredients, proportions and strength of the original mortar. The methods described in ASTM C1324, *Standard Test Method for Examination and Analysis of Hardened Masonry Mortar* [Ref. 1], are generally used to determine the mortar proportions. To avoid irreparable brick damage, the compressive strength of the repointing mortar must be equal to or lower than the compressive strength of the original mortar. It should be emphasized that using a mortar with higher compressive strength may significantly impair the surrounding brickwork. Stronger repointing mortar will increase the stress concentration on the brick/mortar interface and can lead to spalling of the brick face. Type N is generally recommended for modern applications; however, Type O is appropriate for situations where mortars with higher cement contents may be too strong for proper performance. Type K mortar is the weakest and is generally reserved for historic masonry applications. Proper proportions for Type K mortars are 1 part portland cement, 4 parts hydrated lime and 15 parts fine sand. Refer to *Technical Note 8* for material proportions of Type N and Type O mortars.

The repointing mortar should be prehydrated to reduce excessive shrinkage. The proper prehydration process is as follows: All dry ingredients should be thoroughly mixed. Only enough clean water should be added to the dry mix to produce a damp consistency that will retain its shape when formed into a ball. The mortar should be mixed to this dampened condition 1 to 1½ hr before adding water for placement.

The joints to be repointed should be dampened, but to ensure a good bond, the brickwork must absorb all surface water before repointing mortar is placed. Water should be added to the prehydrated mortar to bring it to a workable consistency that is drier than conventional mortar. The mortar should be packed tightly into the joints in layers no more than ¼ in. (6.4 mm) thick, as shown in [Figure 1c](#) and tooled when “thumbprint hard.” The last layer of mortar should be tooled to match the original profile, as in [Figure 1d](#). As it may be difficult to determine which joints allow moisture to penetrate, it is advisable to repoint all mortar joints in the affected wall area.

If only portions of the wall area are repointed, then the repointing mortar should match the color of the existing mortar. Coloring of the mortar with pigments may be required to match the original mortar color. Pigments should be metallic oxides and not organic chemicals. Coloring additives may be added to the mix in quantities not to exceed 10 percent by weight of the portland cement in the mix, with carbon black limited to 2 percent. When matching to existing mortar, compare the newly mixed samples with the existing mortar that has been wetted, and then compare fully dried samples to existing dry mortar. Multiple sample batches and/or custom pigment blends may be required to obtain a match.

## Replacement of Brick

Moisture will also penetrate through areas in the brick that are broken or heavily spalled. When this occurs, replacing the damaged units may be necessary. The procedure shown in [Figure 2](#) is recommended for removing and replacing brick.

For ease of removal, a portion or all of the damaged brick units can be broken. Once the units are removed, the surrounding mortar should be carefully cut and chiseled in such a way as to avoid damaging adjacent brickwork, as shown in [Figure 2b](#). Dust and debris in and surrounding the resulting opening should be carefully removed. If the units are located in the exterior wythe of a drainage wall, then care must be exercised to prevent debris from falling into the air space, which could block weeps and interfere with drainage.

The brick surfaces in the wall should be dampened before new units are placed, but the masonry should absorb all surface moisture to ensure a good bond. The appropriate surfaces of the surrounding brickwork and the replacement brick should be completely buttered with mortar. The replacement brick should be centered in the opening and pressed into position, as shown in [Figure 2c](#). The excess mortar should then be removed with a trowel. Pointing around the replacement brick will help to ensure full head and bed joints. When the mortar becomes “thumbprint” hard, the joints should be tooled to match the original profile.

Mortar proportions are selected as discussed in the previous section, “Repointing Mortar Joints.” The new mortar should have similar physical properties to the existing mortar to ensure proper performance of both the new and existing brickwork. Using the wrong mortar may cause spalling and cracking in the existing brick masonry. Matching the existing mortar color is also important to blend the repaired area with the surrounding masonry.

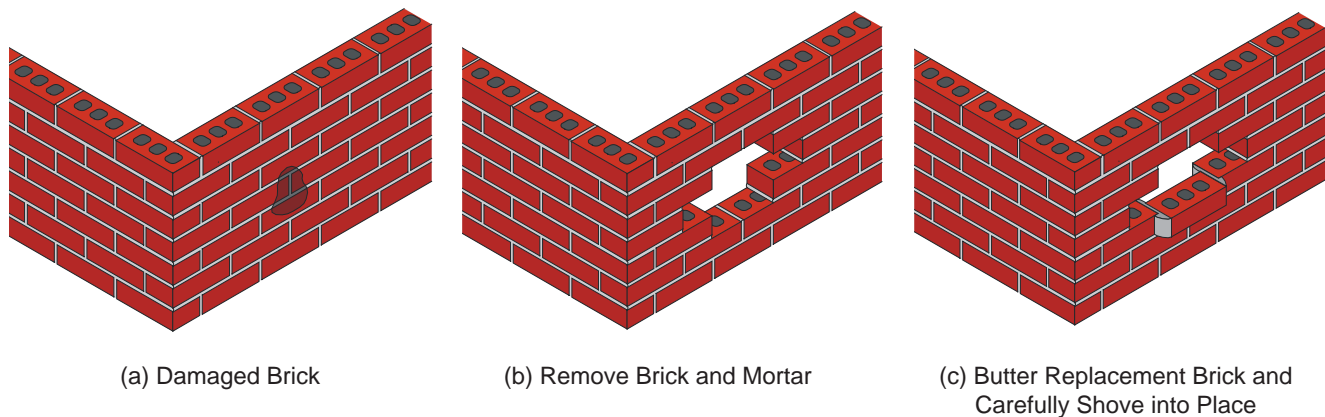

**Figure 2**  
**Replacement of Deteriorated Brick**

Similarly, new replacement brick must match the aesthetic properties of the existing brick, like color, texture and size, as well as its physical properties. Locating matching brick may take considerable effort. To evaluate the accuracy of the match, the size, color and texture of the replacement brick should be compared with the existing brickwork by using a mock-up or sample panel. The brick in the sample panel should represent the full range of colors and textures of the brick selected and should be configured to match the appearance of the existing brickwork. For more information on sample panels and mock-ups, refer to *Technical Note 7B*.

## Plant Removal

Certain types of plant growth may contribute to moisture penetration. For example, ivy shoots, sometimes referred to as “suckers,” penetrate voids in mortar and may conduct moisture into these voids. If this is the case, then ivy removal may be necessary.

To effectively remove ivy and similar plants, the vines should be carefully cut away from the wall. Avoid pulling the vines away from the wall, as this could damage the brickwork. After cutting the ivy, the shoots will remain. These shoots are embedded in the wall and should be left undisturbed until they dry, shrivel and turn dark. This usually takes two to three weeks. Care should be taken not to allow the suckers to rot and oxidize, as doing so can make them difficult to remove without damaging the wall surface. Once these shoots become dry, they can be removed with a stiff fiber brush and laundry detergent. Chemicals or acids should not be used to remove them, as this increases the risk of damaging or staining the wall.

To determine how the wall will appear once the ivy is removed, it is suggested that a small portion of the ivy (5 to 10 sq ft [0.5 to 1.0 m<sup>2</sup>]) be removed from an inconspicuous area first. It is important to inspect the condition and appearance of the exposed area for potential damage or staining of the brick masonry. Repointing of the mortar joints may be necessary if the mortar cracks or deteriorates when removing ivy.

## Opening Weeps

Weeps should be inspected to ensure that they are appropriately spaced and not clogged, so that moisture within the walls is drained to the exterior. If the original weeps were not appropriately spaced, then drilling new supplemental weeps may be necessary. *Technical Note 7* outlines suggested types and spacing of weeps. If weeps are clogged, then they can be cleaned out by probing with a thin dowel or stiff wire. When cleaning or installing weeps, care must be exercised to not damage the existing flashing located immediately below and behind the weeps. The use of a stopper to limit the depth of penetration of the probe or drill bit may be effective in reducing the possibility of damaging the vertical leg of the flashing in the drainage cavity.

## Installation of a Dampproof Course

The movement of moisture up a wall through the brickwork by capillary action is referred to as rising damp. This condition appears as a rising water line or “tide mark” on the wall caused by the soluble salts in the groundwater. As a result, in order to reduce the potential for rising damp, a dampproof course should be installed.



Model building codes require the use of a dampproofing or waterproofing material on the surface of masonry walls located below grade and require base flashing to be installed within 10 in. (254 mm) of final grade. If these are omitted or improperly installed, then rising damp may occur. The insertion of a dampproof course at a level above the ground, but below the first floor, may stop the rising moisture.

There are various methods to install a retrofit dampproof course. One method involves injecting a synthetic chemical that forms a continuous dampproof barrier into an existing brick course. Holes are drilled into the course of brick, and the synthetic material is injected. Another method is the creation of an additional flashing level just above grade. One or more brick courses are removed, flashing is installed and the brick are replaced. Recommendations for brick removal and replacement are discussed in the preceding section. In situations with severe rising damp, excavation of the soil adjacent to the wall and installation of dampproofing or waterproofing materials to the wall surface may be required.

## Installation of Flashing

Building codes require flashing to be designed and detailed to resist water penetration to the interior of the building. Flashing that has been omitted, damaged or improperly installed may permit moisture to penetrate to the building interior. If this is the case, then flashing can be repaired or replaced to correct uncontrolled water penetration related to the flashing system. The procedure is invasive, requiring the removal of brick, bracing the brick above, installing new flashing and replacing the removed brick units. Other methods may be used to address water penetration, but these are not necessarily long-term solutions and will not comply with the building code when flashing is missing. To install continuous flashing in existing walls, alternate sections of masonry in 2 to 5 ft (610 mm to 1.52 m) lengths should be removed. The flashing is installed in these sections, and the opening is filled with new brick and mortar as discussed under “Replacement of Brick”; refer to [Photo 3](#). The replaced masonry should be properly cured (five to seven days) before the intermediate masonry sections or supports are removed. Alternately, temporary braces can be installed if longer sections of brickwork are removed; refer to [Photo 4](#). After these braces are installed, the flashing can then be placed in these sections. The lengths of flashing should be lapped a minimum of 6 in. (152 mm) and the laps adhered and edges sealed with a sealant or adhesive compatible with the flashing material to function properly. See *Technical Note 7* for other flashing installation recommendations.



**Photo 3**  
Flashing Installed in Alternating Sections



**Photo 4**  
Flashing Installation Using Temporary Support

---

## Installation of Wall Ties and Anchors

In instances where masonry walls have been constructed without a sufficient number of anchors or where the existing anchors have failed, proprietary “retrofit” anchors may be used to attach the wythes or veneer and transfer lateral loads. Installing retrofit anchors improves the stability of the masonry and reduces the potential for face cracking. Installation of most retrofit anchors involves drilling small holes in the masonry, usually in a mortar

joint, through which the anchors are attached to the substrate. Generally, mechanical expansion, helical screws, or grout- or epoxy-adhesive systems, shown in **Figure 3**, are used to make the connection.

Because the installation methods and limitations of each product are unique, consultation with the retrofit anchor manufacturer is essential to ensure proper application, detailing, installation, inspection and performance. Mock-up installations and in situ testing of installed anchors in the wall to be repaired should be required to confirm that the retrofit anchors will perform as expected.

## Coatings and Water Repellents

Brickwork that is properly designed, constructed and maintained can be expected to satisfactorily resist water penetration under normal exposures without the application of water repellents or other external coatings. Drainage-type walls, such as brick veneer walls or cavity walls, are designed to accommodate water penetration of the exterior brickwork without damage to the interior components of the wall system through its drainage system. There are some cases in which water repellent use may be warranted; however,

use of external coatings on brick masonry should be considered only after completing repair and replacement of brick, mortar joints and other building elements, and careful consideration of the possible consequences. Although coatings are not required on properly designed, specified and constructed brick masonry, they may be used successfully to alter the appearance of a wall or to diminish the effects of certain deficiencies.

External coatings are most effective in reducing water penetration when their intended use corresponds with the nature of the existing water penetration problem. Application of a water repellent is generally not recommended on newly constructed brick veneer walls or cavity walls. However, water repellents may be used to correct minor deficiencies that remain after completion of repairs or to reduce the amount of water absorbed by barrier walls and masonry subject to extreme exposures, such as chimneys, parapets, copings and sills. Water repellents and coatings should not replace or be considered equivalent to essential, code-required details that resist water penetration, such as flashing and weeps. Use of coatings for reasons outside their intended application rarely reduces water penetration and may lead to more serious complications with the brickwork.

Only water repellents that permit evaporation and the passage of water vapor, such as siloxanes and silanes, should be used on exterior brickwork. Film-forming coatings should not be applied to exterior brickwork.

*Technical Notes 6 and 6A and manufacturers' literature should be consulted before any coating is applied to brickwork.*

## SUMMARY

This *Technical Note* has presented maintenance procedures for brick masonry. Routine periodic inspection of the building is suggested to determine the existing condition of the brickwork and adjacent materials. If distress is noted, then appropriate maintenance tasks should be performed. If the problem is moisture related, then the source of moisture should be determined and corrected before other repairs are initiated.

*The information and suggestions contained in this Technical Note are based on the available data and the combined experience of engineering staff and members of the Brick Industry Association.*

*The information contained herein must be used in conjunction with good technical judgment and a basic understanding of the properties of brick masonry. Final decisions on the use of the information contained in this Technical Note are not within the purview of the Brick Industry Association and must rest with the project architect, engineer and owner.*

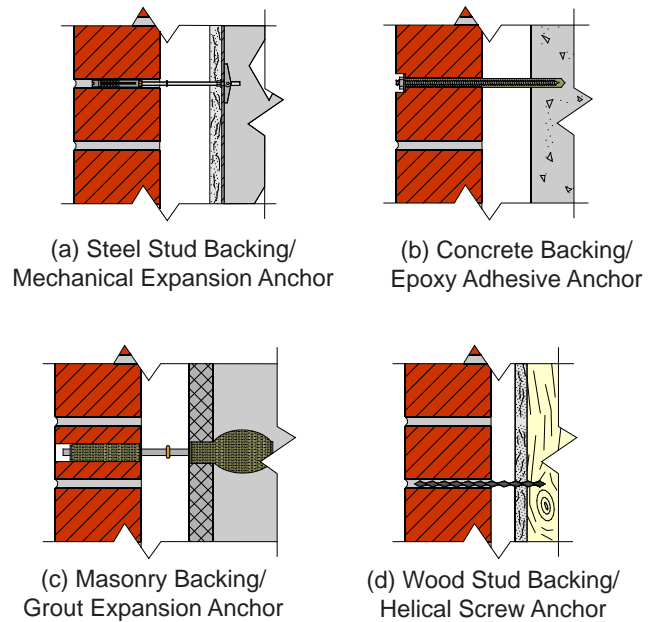

**Figure 3**  
**Masonry Reanchoring Systems**

## REFERENCES

1. ASTM C1324, "Standard Test Method for Examination and Analysis of Hardened Masonry Mortar," *Annual Book of Standards*, Vol. 04.05, ASTM International, West Conshohocken, PA, 2017.
2. "BDA Comment on the Use of Reclaimed Clay Bricks," Brick Development Association, London, UK, January 2014.
3. Brick Brief, "Ivy on Brickwork," Brick Industry Association, Reston, VA, July 2005.
4. Brick Brief, "Repointing (Tuckpointing) Brick Masonry," Brick Industry Association, Reston, VA, July 2005.
5. Brick Brief, "Replacement Brick," Brick Industry Association, Reston, VA, June 2011.
6. Kreh, Richard T. Sr., *Masonry Skills*, Seventh Edition, Delmar Learning, Clifton Park, NY, 2015.
7. London, Mark, *Masonry: How to Care for Old and Historic Brick and Stone*, The Preservation Press, National Trust for Historic Preservation, 1988.
8. Mobley, K., *Maintenance Engineering Handbook*, Eighth Edition, McGraw-Hill Publishing Company, New York, NY, 2014.
9. Preservation Briefs No. 2, "Repointing Mortar Joints in Historic Masonry Buildings," Heritage Preservation Services, U.S. Department of the Interior, Washington, D.C., October 1998.



## REPOINTING (TUCKPOINTING) BRICK MASONRY

### Introduction

The terms pointing, repointing and tuckpointing are often used interchangeably, which has led to confusion within the masonry industry. For years, the Brick Industry Association has used the term "tuck-pointing" to describe one form of maintenance of brick masonry. However, the meaning of tuckpointing may vary by geographical region, leading to conflicts regarding job specifications and expected repairs. Recently these terms have been defined in ASTM E 2260, Guide for Repointing (Tuckpointing) Historic Masonry, as follows:

**Point** - placing mortar into a properly prepared joint

**Repointing** - the process of removal of defective mortar from between masonry units and placement of fresh mortar.

ASTM E 2260 defines tuckpointing as synonymous with repointing, however the term also applies to an older practice of pointing masonry with a flush mortar joint that approximates the color of the masonry units and a mortar of contrasting color that is shaped into a thin strip, giving the appearance of a very thin mortar joint.

This *Brick Brief* covers the process that ASTM E 2260 defines as repointing. Thus the term repoint is used throughout to avoid confusion.

### Why Repoint?

The longevity of mortar joints will vary with the exposure conditions and the mortar materials used. A lifespan exceeding 25 years is typical for mortar joints. The longevity of brick units, however, may well exceed 100 years. Consequently, occasional repair of the mortar joints may be necessary over the life of the brick masonry. The most common reason for repointing brick masonry is to improve water penetration resistance. Repointing deteriorated mortar joints is one of the most effective and permanent ways of decreasing water entry into brickwork. This is because a common means of water entry into a brick masonry wall is through debonded, cracked or deteriorated mortar joints.

### What to Repoint

A critical step in the repointing operation is to identify wall areas that require repointing. This step is critical because only defective joints require repair. Repointing is very labor-intensive work and original mortar joints in good condition are preferable to repointed mortar joints. Conditions that require repointing include:

- mortar erosion exceeding  $\frac{1}{4}$  in. (6.4 mm.)
- crumbling mortar
- mortar with voids
- hairline cracks in the mortar

- cracks between the brick and mortar.

Visual observation in combination with light scraping with a metal tool can detect cracked, spalled and friable mortar joints. This is the most common means of determining areas to be repointed. On older buildings, "cleaning" by low or moderate pressure water wash (not grit or chemical wash) may be required prior to evaluating the condition of existing mortar joints. Consult *Technical Note 20* for proper water washing techniques. Care should be taken to not cause further damage to the brickwork when cleaning.

### Repointing Mortar

The strength, composition and color of the existing mortar should be considered when selecting a repointing mortar.

**Strength.** To avoid irreparable brick damage, the compressive strength of the repointing mortar should be similar to or weaker than the compressive strength of the original mortar. Under load, a stronger repointing mortar will deform less than a weaker original mortar, causing the load to be concentrated on the thin strip of stronger repointing mortar. This stress concentration can lead to spalling of the brick face. The brick masonry is loaded by its self-weight and any externally applied loads present. In addition, the brick masonry is subjected to internal loads due to its thermal expansions and contractions and the shrinkage of the repointing mortar.

Matching compressive strengths of the original and the repointing mortar may be done by matching mortar material proportions. By petrographic or chemical analysis, it is possible to analyze a sample of the original mortar and determine proper proportions of components. ASTM C 1324, Standard Test Method for Examination and Analysis of Hardened Masonry Mortar, can be used to determine the mortar proportions. However, such testing is an added cost, typically only appropriate for historic structure repointing projects which are required to closely match existing conditions. Rather than extensive testing, simply considering the age of the building will give a strong indication of the main contents of the original mortar. For example, mortar containing portland cement was not used in brickwork until after the turn of the twentieth century. Until that time, a common lime and sand mortar in one to three proportions was clearly the most frequently used brick masonry mortar.

**Composition.** Typically, repointing mortar will be Type N, O or K mortar. The proportions of portland cement and lime for Types N and O mortars should be in accor-

dance with ASTM C 270, Standard Specification for Mortar for Unit Masonry or BIA M1-88 (see *Technical Note 8A*). Type K mortar proportions are no longer included in the body of ASTM C 270, but are given in an appendix on repointing. Mortar specifications permit a range of proportions of materials for each type of mortar. However, the following are typical proportions by volume :

- Type N - 1 part portland cement, 1 part hydrated lime, and 6 parts sand
- Type O - 1 part portland cement, 2 parts hydrated lime, and 9 parts sand
- Type K - 1 part portland cement, 4 parts hydrated lime and 15 parts sand

In some cases, it may be necessary to match sand gradation with that in the original mortar. For example, brick masonry constructed with thin mortar joints may require sand with finer maximum particle size than permitted by ASTM C 144, Standard Specification for Aggregate for Masonry Mortar. A matching sand gradation may be determined by analysis of the original mortar. The color of the sand to a large extent influences the mortar color since it is the most prevalent of the mortar constituents. Local sand suppliers should be contacted to match sand color. Water for repointing mortar should be clean and potable and should be free of deleterious amounts of acids, alkalies or organic materials.

**Additives.** In general, the use of chemical additives in the repointing mortar mix should be avoided. However, in many older buildings, the original mortar may contain additional materials such as oyster shells and horsehair. If duplication of the original mortar is required, the repointing mortar should contain these materials in matching quantities. Oyster shells, if required, should be thoroughly washed and rinsed with clear water to remove all traces of salt and biological growth. The oyster shells should be crushed to a size matching that in the original mortar. To avoid detriment to the repointing mortar performance, the quantity of oyster shells should not exceed 2 parts by volume of the mix.

Coloring of the mortar with pigments may be required to match the original mortar color. Pigments should be metallic oxides and not organic chemicals. Coloring additives may be added to the mix in quantities not to exceed 10 percent by weight of the portland cement in the mix, with carbon black limited to 2 percent. When matching an existing mortar compare the mixed sample to existing mortar that has been wetted and then compare fully dried samples.

### **Mortar Preparation and Placement**

The repointing mortar should be prepared and placed in accordance with the procedures given in *Technical Note 7F* and the repointing appendix of ASTM C 270. Prehydration of the repointing mortar is a very important step in the process, as prehydration helps avoid excessive shrinkage of the repointing mortar. Removal of defective mortar and cleaning of the joint prior to repoint-

ing are necessary for successful performance of the repointing mortar. The depth of mortar removal should equal or exceed two times the mortar joint thickness. Proper layering and compaction of the repointing mortar helps develop bond with the adjacent brick and mortar. ASTM E 2260, Standard Guide for Repointing (Tuckpointing) Historic Masonry, provides further information on preparing and repointing mortar joints.

### **Locating a Quality Repointer**

An important step toward a successful repointing job is to secure a qualified and experienced repointing craftsman. An individual who is an excellent mason/bricklayer may not be skilled in repointing. It is suggested that skills be substantiated by prior repointing projects or by pre-qualifying. One method of evaluating craftsmanship is to designate an inconspicuous section of the brick masonry and allow candidates to demonstrate their work. The skills in question are:

- cutting out the mortar joints to the proper depth and profile with minimal damage to adjacent brick
- proper preparation of the mortar for repointing
- proper placement of mortar by layering, compacting and tooling
- accurate color matching to adjacent, original mortar joints.

Cleanliness of the repointing operation is also important, so that extensive cleaning of the finished wall is not necessary.

### **Summary**

These recommendations are necessarily general in nature to address the many scenarios for which repointing may be required. The application of these recommendations should be done with skill and engineering judgment. Where repointing work on structures of artistic, architectural, cultural or historical significance is considered, guidance from a preservation specialist should be sought.

*Brick Briefs are short discussions of a particular topic. The information contained herein is based on the experience of Brick Industry Association technical staff and must be used with good technical judgment. Final decisions on the use of this information must rest with the project designer and owner.*

## EFFLORESCENCE PREVENTION AND CONTROL

### Introduction

Efflorescence is a white, crystalline deposit on the surface of concrete or clay masonry that is comprised of water-soluble salts. Efflorescence begins when soluble salts and other compounds are dissolved in water, which becomes a salt solution. This salt solution migrates to the surface of masonry through the masonry units or the mortar. The water evaporates and leaves the salts on the surface of the masonry as efflorescence.

Since efflorescence appears on the face of the brickwork, it is often erroneously assumed to originate from the brick itself. Fired clay brick is rarely the source of efflorescing salts. Instead, it is much more common for efflorescence to be caused by the transfer of soluble salt from cement-based mortar, grout or concrete masonry that is in direct contact with the clay brick used in the wall. This is known because clay brick, unlike other building materials, can be tested to determine its potential to contribute to efflorescence. This test, found in ASTM C67, rates a clay brick as “non-effloresced” when it does not exhibit efflorescence after partial immersion in distilled water for seven days. When similar testing is conducted on a material containing cement, the material typically fails. Non-efflorescing brick are readily available throughout the United States.



**Photo 1: New Building Bloom.** This type of efflorescence may begin before construction is completed.

Efflorescence that occurs on brickwork less than a year old is often attributed to “new building bloom,” as shown in Photo 1. In most cases, new building bloom will dissipate over time if the brickwork is allowed to dry after completion and if environmental factors such as wind and rain are given sufficient time to naturally clean the brickwork. Efflorescence that occurs a year or more after construction is complete is generally attributed to excessive water penetration or poor drainage.

While more information on how to deal with efflorescence can be found in *Technical Note 23A*, “Efflorescence – Causes and Prevention,” this *Brick Brief* furnishes suggestions on how proper material selection, design and detailing and construction practices can help minimize its occurrence.

### Material Selection

Architects and specifiers can refer to ASTM C1400, “Standard Guide for Reduction of Efflorescence Potential in New Masonry Walls,” which provides guidance to reduce the possibility of efflorescence in new buildings. More importantly, it should be kept in mind that all mortar, grout and concrete masonry units contain cement with varying degrees of water-soluble alkalis (water-soluble compounds) — usually the principal contributors to efflorescence.

Cements high in alkaline content are more prone to produce efflorescence than cements of lower alkaline content. Consequently, low-alkali cement should be specified when available to minimize the potential of efflorescence and new building bloom as well.

Careful selection of other products can also help reduce efflorescence potential. Specifying potable water and clean, washed sand for mortar or grout is recommended. It is also recommended to choose building trim, such as caps, coping and sills, that are not made of materials that contain soluble salts, which can increase efflorescence potential over prolonged exposure to water washing over its surface.

### Design and Detailing

While rainwater can penetrate all masonry walls to some degree, proper design can limit available moisture, which in turn helps to suppress the development of



efflorescence. Design measures that help improve the resistance of brickwork to efflorescence include the following:

**Air space.** For more than 40 years, BIA has recommended drainage walls that incorporate an air space because they separate the exterior brickwork from other elements in a wall assembly (see Figure 1). The air space allows the water to drain down the back of the brick wythe and prevents the migration of salts from backing materials by isolating the brick wythe from the materials containing soluble compounds. The air space must be kept clean during construction to allow drainage and to prevent water from bridging the air space and transferring soluble salts from other sources.

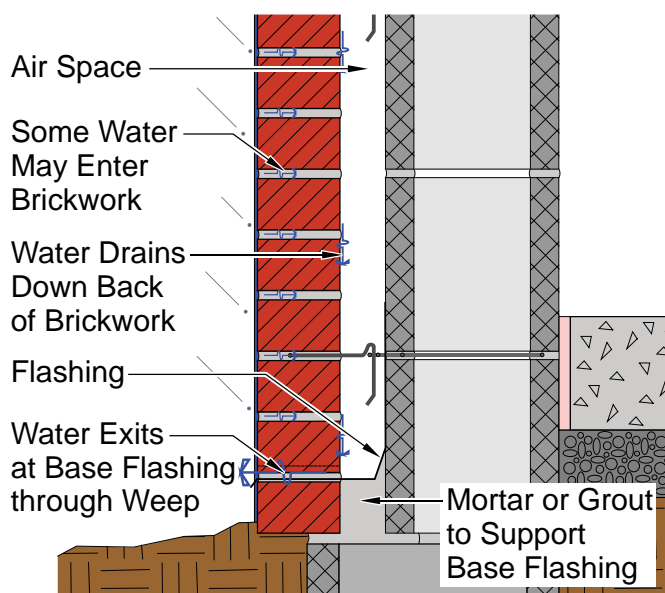

**Figure 1: Drainage Wall Systems.** BIA recommends the use of drainage wall systems, as shown above. BIA does *not* recommend the barrier strategy of filling a collar joint between masonry wythes because it places a source of salts in direct contact with the brickwork.

**Flashing on trim.** Trim materials are frequently used in locations most vulnerable to water penetration, such as caps, coping and sills under windows. These materials also may contain salts that contribute to efflorescence. To minimize efflorescence, buildings should include flashing or other materials to act as a capillary break, as well as a prevention of contact, between trim materials and the brickwork. Since moisture may still wash over trim material and collect water-soluble materials, the use of low-alkali materials can minimize efflorescence even more.

**Waterproof below-grade masonry.** Most groundwater contains a high concentration of soluble salts, which can

accumulate in the masonry. To eliminate these salts as sources of efflorescence, BIA recommends waterproofing the masonry below grade and placing base flashing such that it drains water out of the wall a few courses above grade. Mortar or grout should be used to support the base flashing below the air space, as shown in Figure 1.

### Construction Practices

Several steps can be taken to reduce the amount of water that accumulates in masonry materials during the construction process, including the following:

**Storage of materials.** All masonry units should be stored off the ground to avoid contact with rain or snow, groundwater or contamination by dirt and plant life. These materials should also be covered by a waterproof membrane to keep them dry.

**Water.** Clean, potable water free of salts and other materials should always be used.

**Proper filling of mortar joints.** Attention to both the complete filling of mortar joints intended to receive mortar, as well as keeping all cavities and air spaces clean and free of mortar droppings, is absolutely critical.

**Covering unfinished brickwork.** Unfinished brickwork should be covered with water-resistant membranes or tarps held in place by weights or ropes at the end of each workday. Otherwise, partially completed masonry walls exposed to rain and other elements can become saturated with water that can take weeks — if not months — to dry after the completion of the building.

**Sealant joints.** Joints between masonry and door and window frames, expansion joints and other locations where sealants are required should be treated with care since they are the most frequent sources of rain penetration into masonry.

### Moving Forward

While the above-mentioned measures are helpful today, it should be noted the National Brick Research Center (NBRC), headquartered at Clemson University, has been developing a test method that consistently evaluates materials that potentially contribute to efflorescence by measuring soluble salts with ion chromatography. Ultimately, a set of guidelines can be used to select masonry materials, which will be very significant in helping to curtail the potential for efflorescence.

*Brick Briefs are short discussions of a particular topic. The information contained herein must be used with good technical judgment. Final decisions on the use of this information must rest with the project designer and owner. © 2009 Brick Industry Association.*

## IVY ON BRICKWORK

### Introduction

Ivy growth on brickwork in some locales is common - especially on older brick masonry. Some would say that ivy and brickwork naturally go together. But while allowing ivy to grow on brickwork does impart some benefits, it can also be detrimental. This *Brick Brief* addresses the advantages and disadvantages of ivy growth and how to remove it if desired.

### Ivy, Yes or No?

There is no single easy answer to this question. All of the facts must be considered in any evaluation of the beauty and desirability of ivy growing on brick masonry. Presuming that the wall is known to be well-built with quality materials, it can be expected to last hundreds of years. However, the growth of ivy on a wall, even if it is not removed by force or with chemicals, may shorten the life of a well-constructed wall. If the walls are not properly constructed of quality units, properly prepared mortar with well-tooled joints and good workmanship practices (all joints completely filled) the wall may be more susceptible to damage.

### Disadvantages of Ivy:

- The tentacles and tendrils of some climbing ivy can, over a period of time, dislodge mortar and masonry units.
- The tendrils and plant growth may discolor the brickwork.
- Plant growth (ivy) on the face of brick masonry may tend to keep moisture entrapped and in contact with the masonry. This may lead to or contribute to efflorescence or staining of the wall.
- Ivy and other plant growth can also become a harbor for nesting insects, birds or other animal life and offer them easy access to the inside of the building.
- Removal is difficult at best and may damage the masonry.

### Advantages of Ivy:

- Ivy reduces wall temperature, possibly reducing summer cooling costs.
- Ivy sheds rainwater, possibly reducing moisture contacting the wall.
- Aesthetically desirable in the opinion of some people individuals.

Proper maintenance of walls with growing vines includes keeping the vines trimmed around and away from windows, gutters, eaves, woodwork, and other decorations.

### Removal of Ivy

Before deciding to remove ivy, several questions should be answered:

- What are the reasons for removing the ivy?
- Is the wall properly constructed of quality materials and good craftsmanship?
- What is the value, both aesthetically and ecologically speaking, of ivy on the wall?

If removal is considered, it should be attempted in a small area. Avoid pulling the vines away from the wall since this may damage the brick or mortar. Carefully cut away a few square feet of vine in an inconspicuous area and see how much the ivy has rooted into the brickwork. Also, inspect the exposed area for condition and appearance. Then visualize the prospective appearance of the wall with the vines cut away. Repointing or other repairs may be necessary if the ivy is removed. These issues should help you decide if de-vining is necessary or feasible.

If it is decided to remove the ivy, carefully cut it away close to the wall. There will be some remnants left on the wall. These are "suckers" embedded in the brickwork that previously attached and held the vines. **DO NOT** use chemicals or acids to try to remove them - since this increases the risk of damaging or staining the wall. The suckers should be left in place until they dry up and turn dark. They can then be removed with a stiff fiber brush and some laundry detergent. Do not wait too long because if the suckers rot and oxidize, they may become very hard and nearly impossible to remove without doing damage to the wall surface. Two or three weeks should be sufficient time.



*Brick Briefs are short discussions of a particular topic. The information contained herein is based on the experience of Brick Industry Association technical staff and must be used with good technical judgment. Final decisions on the use of this information must rest with the project designer and owner.*

## **MASONRY CHIMNEY MAINTENANCE / REPAIR**

---

Masonry chimneys can be a source for problems such as leaking, efflorescence, and spalling if proper construction details have not been utilized. The following guidelines include information a homeowner or builder can use to correct and repair common chimney problems.

A poor cap is probably the most common source of chimney problems. The cap should be closely inspected for cracks or other sources of water leakage. The best chimney cap is a poured concrete cap with a 1 ½" overhang and a drip notch. The detail for this type of cap is indicated in "Recommended Details Essential to Durable Brick Homes". These printed details are included on the package card attached to every cube of brick delivered to the site. A metal cap can also provide very effective weather protection and can be more economical than a concrete cap when used as a repair.

Corbel details can also be a potential source of water penetration. Corbels can act as ledges which allow water to accumulate and eventually work its way into the masonry. If the corbel details have exposed core holes the problem is further aggravated. A simple mortar bevel applied to the corbel can help eliminate this problem. For this repair Type S mortar is recommended.

Roofing counter flashing should be inspected for possible sources of leakage and caulked or repaired as required.

The chimney should also be inspected for unfilled mortar joints. Any holes or partially filled joints should be properly tuck pointed.

A chimney cricket should be installed as required by section 1001.16 of the CABO One and Two Family Dwelling Code. The CABO Code requires a cricket when the chimney dimension parallel to the ridge line is greater than 30 inches and the chimney does not intersect the ridge line.

The application of a water repellent can also provide additional protection from leakage. If a water repellent is applied it is important that only a breathable Siloxane based material be used. One such product is Weather Seal Siloxane by ProSoCo, Inc. Acrylic sealers should not be used for any type of exterior application. Any repairs such as tuck pointing, corbel bevels, or chimney cap repairs must be completed before a water repellent is applied. To allow for maximum penetration the masonry must be completely dry before a water repellent is applied. All manufacturers should be closely followed. For additional information on water repellents you can contact ProSoCo, at 1-800-255-4255.

The following detail illustrates some of the repairs discussed above. If you have questions or require additional information contact the General Shale Engineering Department at (423) 282-4661.



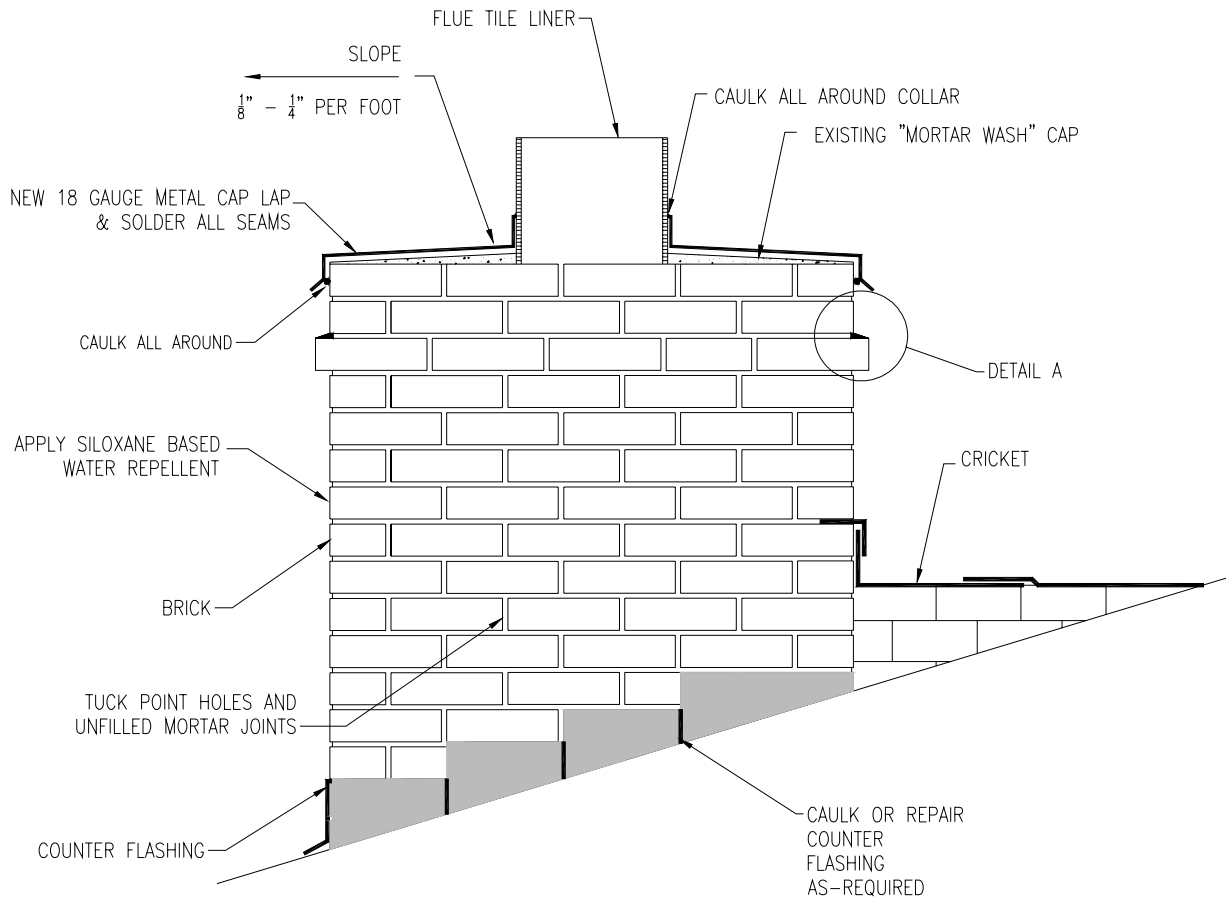

### MASONRY CHIMNEY ELEVATION

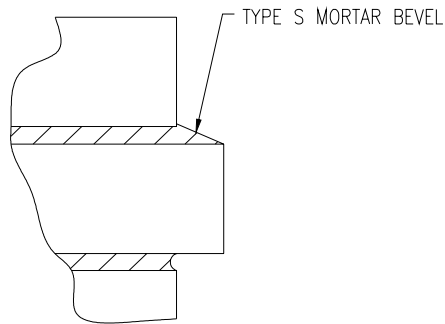

DETAIL A

THE DETAILS AND DATA CONTAINED IN THIS LITERATURE ARE FOR INFORMATION ONLY. ALL DESIGNS AND DETAILS USED IN CONSTRUCTION MUST BE REVIEWED, APPROVED AND SEALED BY A REGISTERED PROFESSIONAL ENGINEER. NO WARRANTIES (EXPRESS, IMPLIED OR STATUTORY) ARE MADE IN CONNECTION WITH THE STRUCTURAL DETAILS AND DATA CONTAINED HEREIN.



MASONRY CHIMNEY REPAIRS  
 RECOMMENDED DETAILS ESSENTIAL TO DURABLE  
 HOME CONSTRUCTION